

Mvula

Cfb - Temperate climate without dry seasons

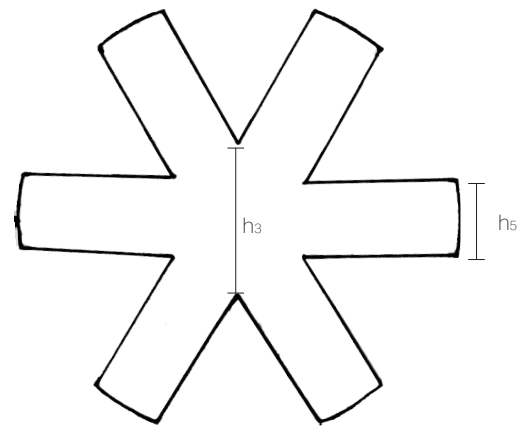

A

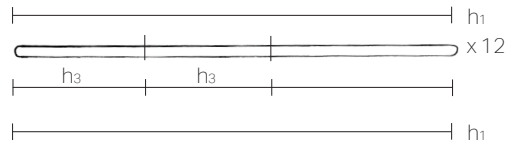
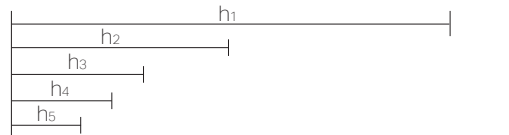
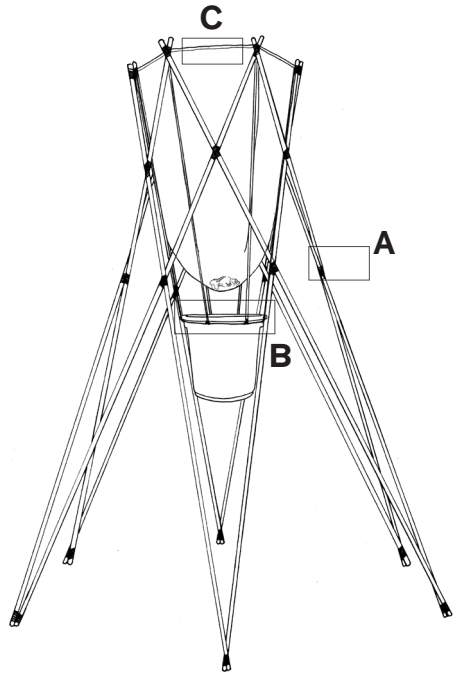
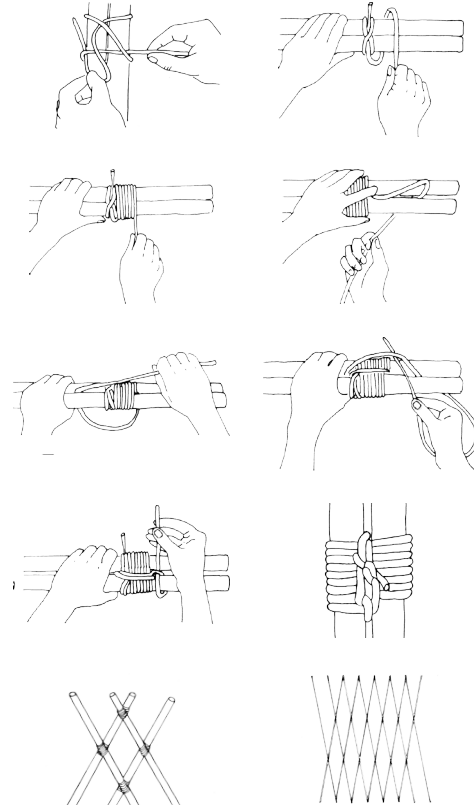

the principle

The higher the connections, the stronger the structure



The more connections, the stronger the structure

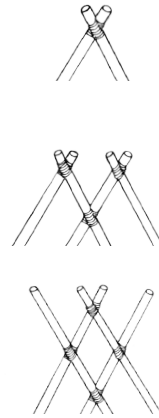

The thinner the angle, the larger the harvest

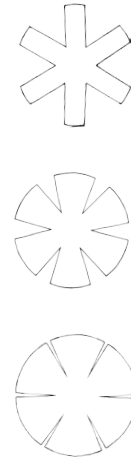

B

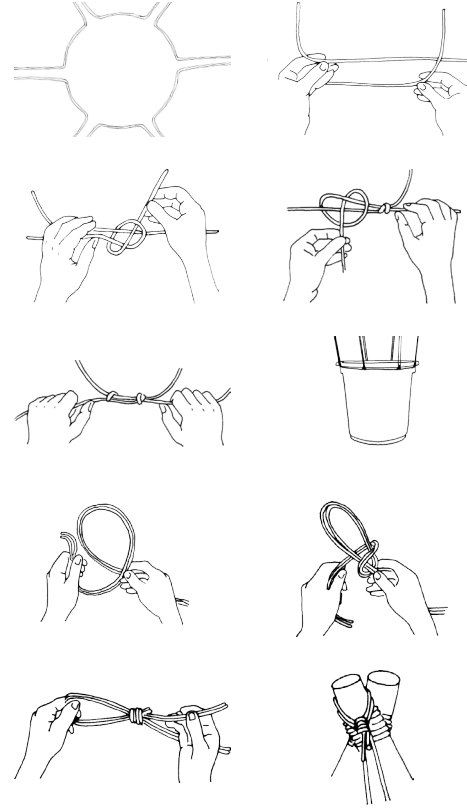

C

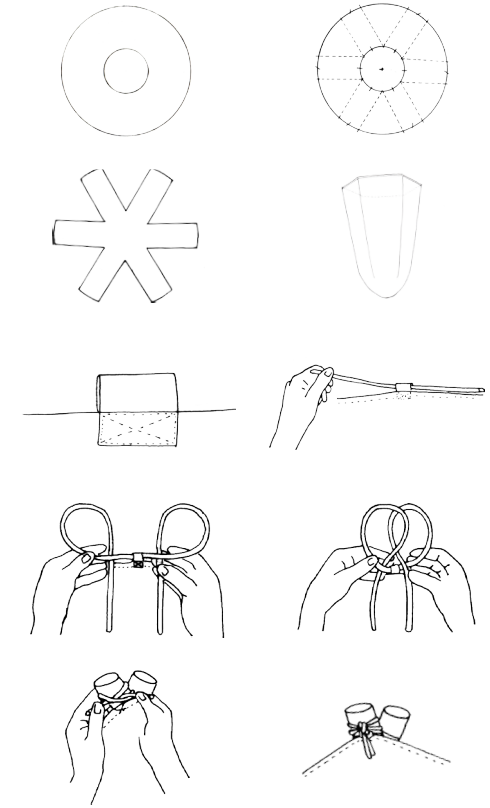

purify the water

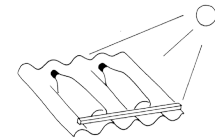

By filling clear plastic bottle 'PET' and expose it to the sun for at least 6 hours



By boiling it



By using your own filter